

*Council of
Canadian Fire Marshals
and Fire Commissioners*



*Conseil canadien
des directeurs provinciaux et
des commissaires des incendies*

Annual Report 1998



Fire Losses in Canada

Annual Report 1998



Fire Losses in Canada

The 1998 "Fire Losses in Canada" Annual Report is prepared by the Occupational Safety and Health and Fire Prevention Division, Human Resources Development Canada and is published by the Council of Canadian Fire Marshals and Fire Commissioners. Copies may be purchased at a cost of \$10.00 each (taxes included) from the Council. See order form at back of report.

Prepared: March, 2002

PREFACE

The Council of Canadian Fire Marshals and Fire Commissioners (CCFM/FC) is a national organization through which issues relating to fire prevention can be discussed constructively in an atmosphere of mutual respect, cooperation and understanding. Its primary objective is to advise on and promote legislation, policies, and procedures pertinent to fire protection; participate in the development of codes and standards relating to fire safety; promote fire safety awareness; support the professional development of the Canadian fire service; identify trends relative to the causes and the severity of fire; provide advice to Accredited Agencies involved in the certification and testing of fire protection equipment and materials relating to fire safety and provide a forum for the exchange of information on fire safety matters.

The 1998 Annual Report of Fire Losses in Canada is the seventy-seventh edition to be published. It is prepared by the Occupational Safety and Health and Fire Prevention Division of Human Resources Development Canada, pursuant to federal government fire protection policy, and it is compiled from information supplied by the Council of Canadian Fire Marshals and Fire Commissioners (CCFM & FC), Indian and Northern Affairs Canada (INAC) and Statistics Canada.

Sincerely,

W.P. Worona
Director
Occupational Safety and Health
and Fire Prevention Division
Human Resources Development Canada

Table of Contents

Section I	
Summary 1989 - 1998	
Table 1 - Canada Fire Losses, Fire Deaths and Fire Injuries	1
Figure 1 - Canada Fire Losses, Actual and Adjusted	2
Figure 2 - Canada Fire Deaths and 10-Year Average	3
Figure 3 - Canada Fire Injuries and 10-Year Average	4
Section II	
Fire Losses, 1998 and 10-Year Average	
Table 2 - Property Losses by Jurisdiction	5
Section III	
Fire Losses by Property Classification	
Table 3 - Summary of Fires by Property Classification	6
3(a) Residential Occupancies	7
3(b) Residential - Detail	8
3(c) Assembly	9
3(d) Assembly - Detail	10
3(e) Institutional	11
3(f) Institutional - Detail	12
3(g) Business and Personal Service	13
3(h) Mercantile Properties	14
3(i) Industrial Manufacturing Properties	15
3(j) Storage Properties	16
3(k) Special Properties (Outdoor and Vehicles)	17
3(l) Special Properties - Detail	18
3(m) Farm Properties	19
3(n) Miscellaneous Properties	20
Section IV	
Table 4 - Arson	21
Section V	
Table 5 - Fire Losses by Source of Ignition	22
Figure 4 - Source of Ignition	23
Section VI	
Table 6 - Fire Deaths and Injuries	
Table 6(a) - Fire Deaths, 1998 and 10-Year Summary	24
Table 6(b) - Fire Injuries, 1998 and 10-Year Summary	25

Section VII		
	Table 7 - Act or Omission Causing Fire.....	26
	Figure 5 - Act or Omission Causing Fire.....	27
Section VIII		
	Table 8 - Losses of \$500 000 and over	
	Table 8(a) Alberta.....	28
	Table 8(b) British Columbia.....	29
	Table 8(c) Manitoba.....	30
	Table 8(d) New Brunswick.....	30
	Table 8(e) Newfoundland.....	31
	Table 8(f) Nova Scotia.....	31
	Table 8(g) Ontario.....	31
	Table 8(h) Prince Edward Island.....	32
	Table 8(i) Quebec.....	33
	Table 8(j) Saskatchewan.....	33
	Table 8(k) Northwest Territories.....	35
	Table 8(l) Yukon.....	36
	Table 8(m) National Defence.....	36
	Table 8(n) Indian Reserves.....	36
	Table 8(o) Federal Properties.....	37
Appendix		
	Order form.....	38
	Provincial and Territorial Fire Marshals and Fire Commissioners.....	39

SUMMARY

In 1998, a total of 57 602 fires were reported; 337 fire deaths; 2 697 fire injuries; and a total of \$1 175 553 135 in property losses.

The "Residential Property" classification continues to account for the largest number of fires. In 1998, there were 23 546 fires in this category, 41% of the Canadian total. These incidents resulted in 258 deaths or approximately 76% of the nation's fire fatalities. The monetary loss amounted to \$525 million, which is 44% of the total loss.

The property classification showing the second largest number of fires is "Special Properties," where 21 688 fires were reported, accounting for approximately 37% of the overall Canadian total. Ground transport vehicle under "Special Properties" accounted for 13 536 incidents of all fires within this property classification, amounting to a dollar loss of \$84 million. The total dollar loss for the "Special Properties" classification is \$121 million.

In the category "Source of Ignition" the following three groups (not including miscellaneous and undetermined) lead the list of number of reported fires and property dollar loss: "Smoker's Material and Open Flame" with 11 535 and a dollar loss of \$220 766 124, "Cooking Equipment" with 6 230 incidents and a loss of \$69 million, and "Heating Equipment" with 5 293 incidents and a loss of \$117 million.

Table 7 provides a review of the fire data identified under the heading of "Act or Omission." As in the past, the category of "Mechanical, Electrical Failure and Malfunction" had the greatest number of recorded fires, that being 12 246. The 1998 dollar loss for this category is \$217 million. "Arson or Other Set Fires" accounted for 10 624 incidents with a dollar loss of \$258 230 339 .

In summary, "Residential Properties" remains an area of utmost concern, accounting for 76% of the total number of fire deaths, 41% of the total number of fires, and 45% of the total dollar loss. The large number of electrical incidents and the associated dollar loss, as well as the number of "Arson or Other Set Fires" and the associated dollar loss, are two other areas of major concern within the Fire Services. A continued effort by all fire protection authorities as well as the public is most imperative in order to reduce the loss of lives, number of fires and property damage.

Section I

Summary 1989 - 1998

Table 1 - Canada Fire Losses, Fire Deaths and Fire Injuries

Year	Estimated Population*	Number of Fires	\$ Loss	Per Capita \$ Loss	Fire Deaths	Death Rate**	Injuries	Injuries Rate**
1989	26 286 239	67 182	1 119 579 909	41.03	500	1.83	3 763	13.79
1990	27 700 856	67 556	1 225 993 172	44.26	461	1.66	3 753	13.55
1991	28 030 864	68 150	1 239 716 205	44.23	388	1.38	3 476	12.40
1992	28 376 550	65 999	1 241 390 000	43.75	401	1.41	3 874	13.65
1993	28 703 142	65 877	1 181 892 872	41.18	417	1.45	3 463	12.06
1994	29 035 981	66 719	1 151 546 461	39.66	377	1.30	3 539	12.19
1995	29 353 854	64 251	1 110 839 184	37.84	400	1.36	3 551	12.10
1996	29 671 892	60 138	1 163 336 515	39.21	374	1.26	3 152	10.62
1997	30 003 955	56 292	1 291 640 983	43.05	416	1.39	3 149	10.50
1998	30 300 422	57 602	1 175 553 135	38.80	337	1.11	2 697	8.90
10-Year Average		63 977	1 190 148 844	41.30	407	1.42	3 442	11.98

* Source: 1998 Census, Statistics Canada

** Fire deaths rate and fire injuries rate - number of deaths/injuries per 100 000 population per annum

Figure 1 - Canada Fire Losses, Actual and Adjusted Dollar Losses in Millions

Summary 1989 – 1998

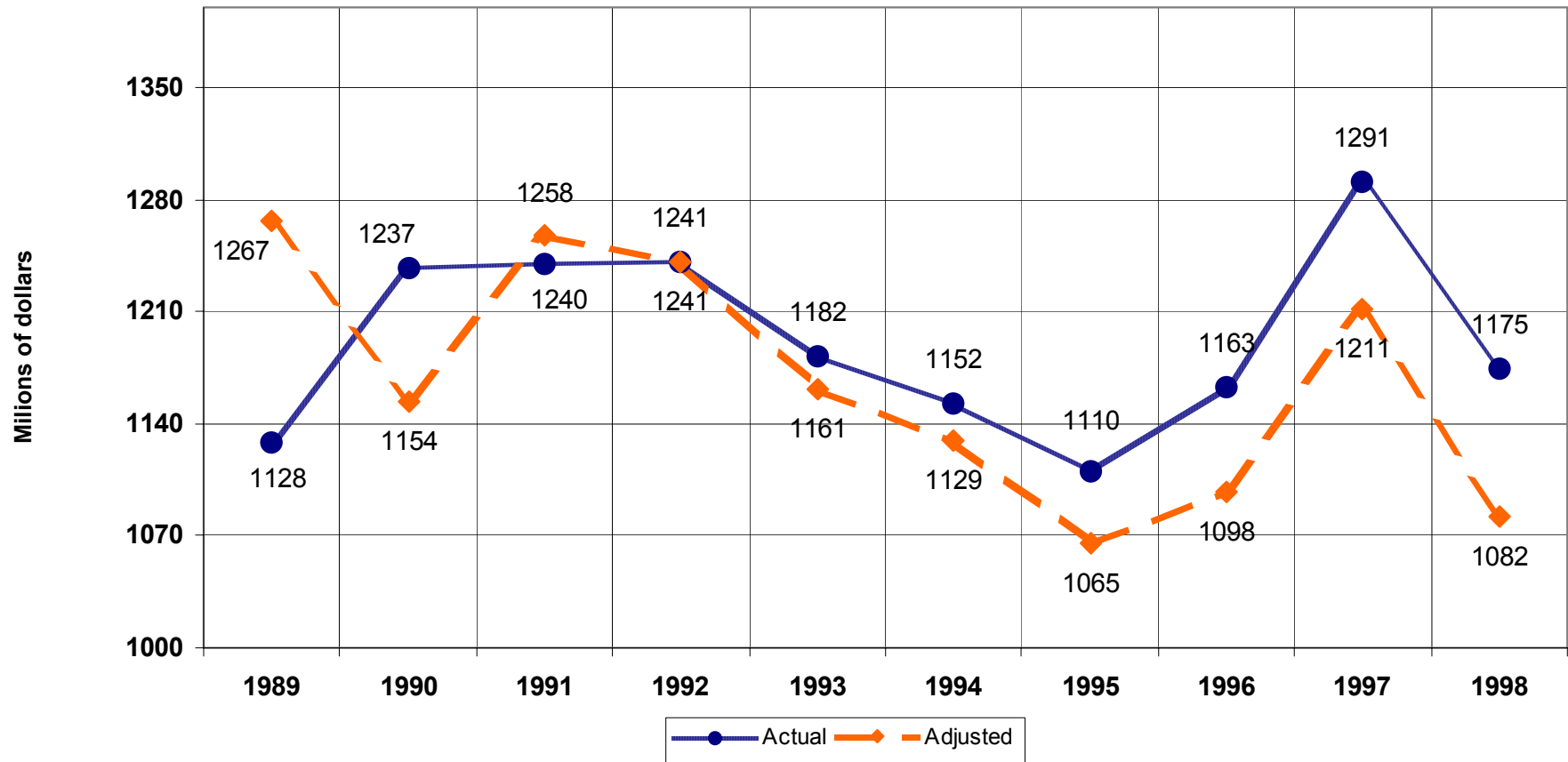

Adjusted to 1992 dollars using the Consumer Price Index, All Commodities

Figure 2 - Canada Fire Deaths and 10-Year Average

Summary 1989 - 1998

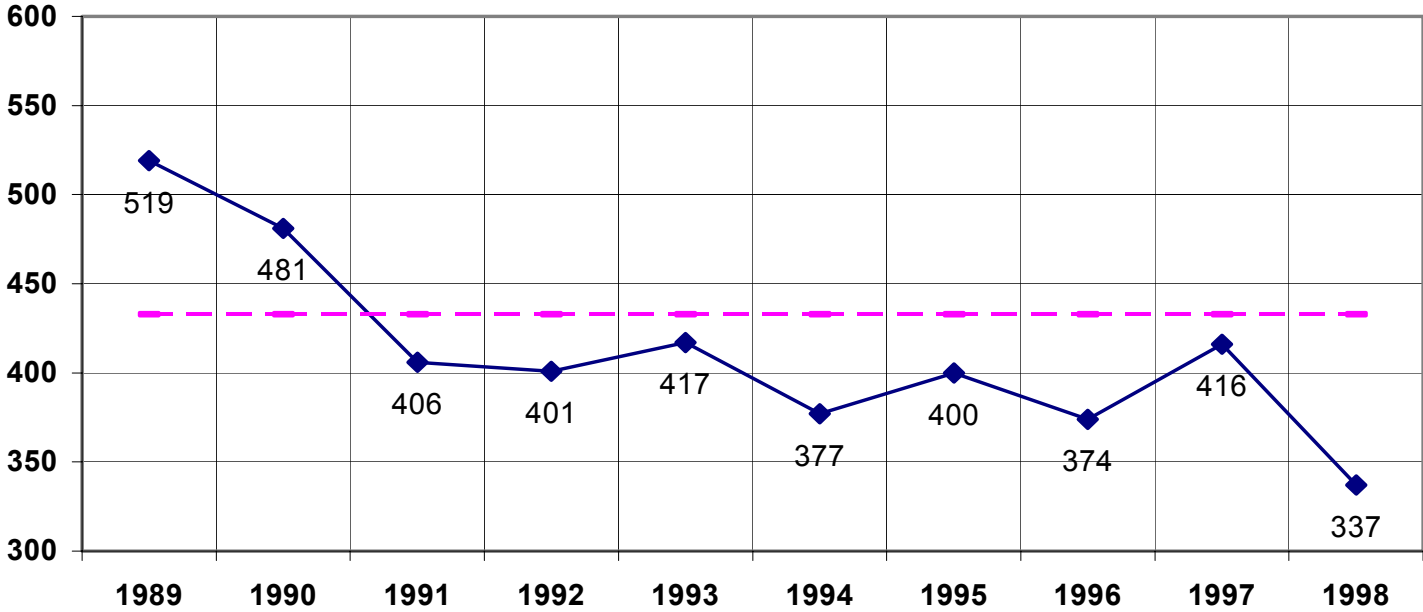
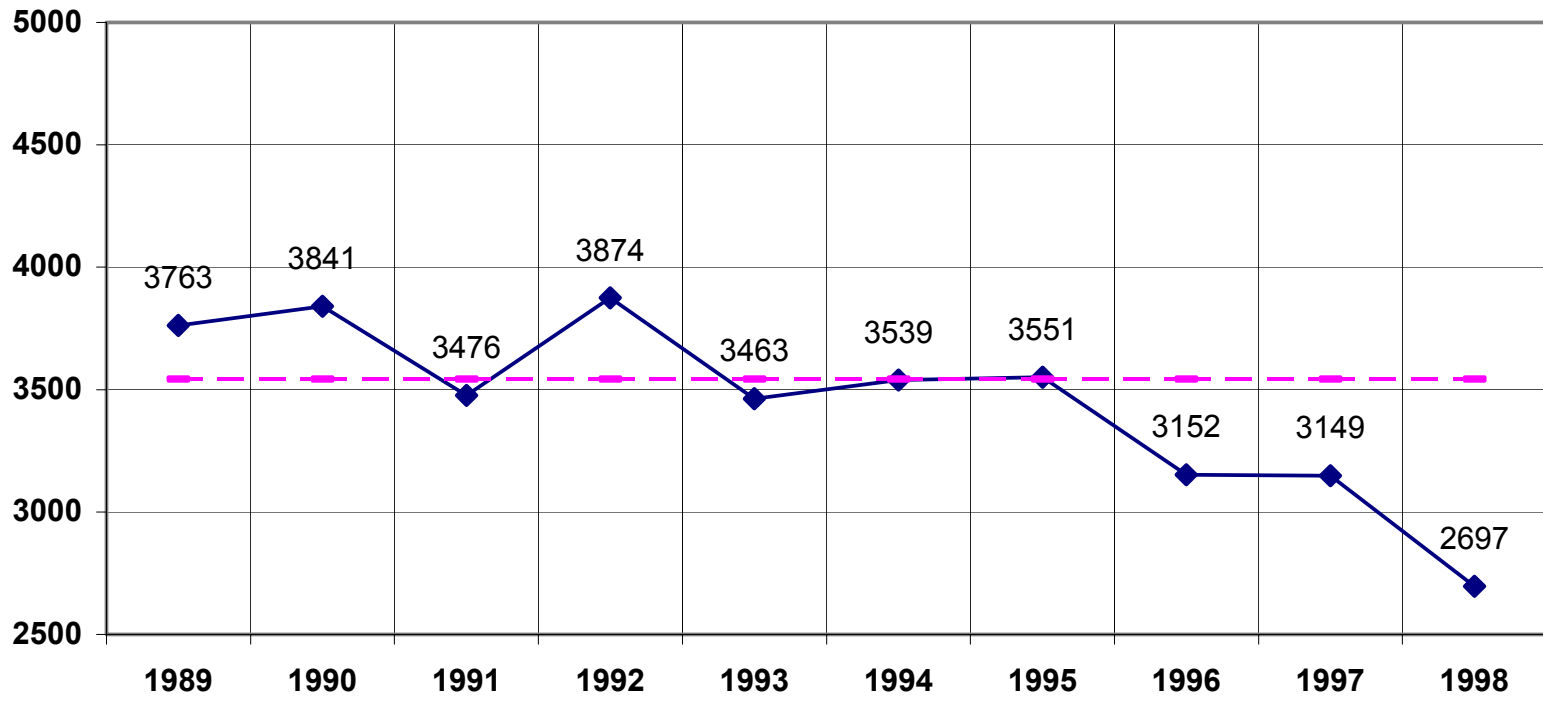

Figure 3 - Canada Fire Injuries and 10-Year Average

Summary 1989 - 1998



Section II

Fire Losses, 1998 and 10-Year Average

Table 2 - Property Losses by Jurisdiction

Jurisdiction	Estimated Population 1998*	<u>Number of Fires</u>		<u>\$ Loss</u>		<u>Per Capita \$ Loss</u>	
		1998	10-Year Average	1998 \$	10-Year Average	1998 \$	10-Year Average
Alberta	2 914 918	6 570	6 972	138 723 933	114 884 532	47.59	42.65
British Columbia	4 009 922	6 668	7 288	153 787 992	169 752 010	38.35	47.19
Manitoba	1 138 872	5 659	5 665	64 753 668	59 896 295	56.86	53.39
New Brunswick	752 999	2 516	2 202	39 904 209	20 892 084	52.99	27.91
Newfoundland	544 400	573	657	21 934 917	23 347 287	40.29	40.96
Nova Scotia	934 587	1 601	2 121	15 249 301	22 693 384	16.32	24.64
Ontario	11 411 547	18 221	21 846	288 231 652	362 056 345	25.26	33.74
Prince Edward Island	136 388	N/A	679	N/A	4 900 466	0.00	37.09
Quebec	7 333 283	10 233	12 150	382 223 164	346 703 990	52.12	48.38
Saskatchewan	1 024 387	4 098	3 280	41 533 402	38 358 760	40.54	37.86
Northwest Territories	67 468	132	164	14 539 806	9 489 679	215.51	146.94
Yukon	31 651	238	266	1 107 285	4 397 800	34.98	143.32
National Defence	85 973	305	190	1 570 318	2 445 390	18.27	22.61
Indian Reserves	325 475	670	391	10 944 651	7 580 812	33.63	24.20
Federal Properties	207 265	118	97	1 048 837	2 760 010	5.06	12.50
Summary	30 300 422	57 602	63 967	1 175 553 135	1 190 148 844	38.80	39.46

* Source: 1998 Census, Statistics Canada. The summary total for the population does not include National Defence, Indian Reserves and Federal Properties.

Section III

Fire Losses by Property Classification

Table 3 - Summary of Fires by Property Classification

Classification	Number of Fires	% of Total	\$ Loss	% of Total	Injuries	% of Total	Deaths	% of Total
Residential	23 546	40.88	525 332 902	44.69	1 873	69.45	258	76.56
Assembly	1 793	3.11	77 465 908	6.59	86	3.19	0	0.00
Institutional	527	0.92	15 146 426	1.29	46	1.71	4	1.19
Business and personal service	639	1.11	30 208 858	2.57	41	1.52	4	1.19
Mercantile	1 435	2.49	86 280 095	7.34	75	2.78	5	1.48
Industrial manufacturing properties	1 447	2.51	146 234 683	12.44	129	4.78	6	1.78
Storage properties	1 450	2.52	48 531 684	4.13	54	2.00	4	1.19
Special properties	21 688	37.65	121 857 388	10.36	231	8.56	39	11.57
Farm properties	912	1.58	33 963 159	2.89	11	0.41	3	0.89
Miscellaneous properties*	4 165	7.23	90 532 032	7.70	151	5.60	14	4.15
Total	57 602	100.00	1 175 553 135	100.00	2 697	100.00	337	100.00

* 1998 total losses for Newfoundland and Indian Reserves have been included under Miscellaneous Properties as their losses by specific property classifications are not available.

3(a) Residential Occupancies

Jurisdiction	1998				10-Year Average 1989 - 1998			
	Number of Fires	% of Total	\$ Loss	% of Total	Number of Fires	% of Total	\$ Loss	% of Total
Alberta	1 744	26.54	47 699 669	34.38	1 379	21.00	35 442 133	25.55
British Columbia	2 332	34.97	72 957 414	47.44	2 720	40.79	69 603 317	45.26
Manitoba	1 372	24.24	22 941 172	35.43	1 660	29.33	23 472 822	36.25
New Brunswick	1 440	57.23	11 875 136	29.76	1 204	47.86	11 635 288	29.16
Newfoundland*	N/A	N/A	N/A	N/A	123	21.52	2 484 052	11.32
Nova Scotia	1 137	71.02	7 990 730	52.40	1 327	82.89	13 975 710	91.65
Ontario	7 420	40.72	160 750 672	55.77	9 695	53.21	169 629 347	58.85
Prince Edward Island	N/A	N/A	N/A	N/A	372	0.00	4 492 247	0.00
Quebec	7 180	70.17	180 014 536	47.10	6 828	66.72	162 000 963	42.38
Saskatchewan	736	17.96	16 035 199	38.61	796	19.42	12 093 960	29.12
Northwest Territories	63	47.73	3 939 116	26.40	139	105.00	4 133 857	28.43
Yukon	85	35.71	763 000	68.96	97	40.59	1 218 436	110.04
National Defence	36	11.80	465 558	29.65	49	16.07	387 589	24.68
Indian Reserves*	N/A	N/A	N/A	N/A	69	12.80	1 772 551	16.37
Federal Properties	1	0.85	100	0.01	2	1.69	46 496	4.43
Total	23 546	40.88	525 332 902	44.69	26 459	45.82	512 378 767	43.44

Percentages used in this table relate to jurisdictional totals.

* 1998 total losses for Newfoundland and Indian Reserves have been included under table n) Miscellaneous Properties as their losses by specific property classifications are not available.

3(b) Residential - Detail

Occupancy	Number of Fires	\$ Loss	Injuries	Deaths
One and two family residence	10 916	254 951 128	989	127
Apartment, tenement, flat	3 605	56 186 513	458	41
Rooming, boarding, lodging	152	3 023 150	40	4
Hotel, inn, lodge	201	6 309 508	28	0
Motor hotel, motel	58	651 964	7	1
Dormitory	60	1 160 622	5	0
Mobile home, trailer	702	14 323 228	43	12
Miscellaneous	7 852	188 726 789	303	73
Total	23 546	525 332 902	1 873	258

3(c) Assembly

Jurisdiction	Number of Fires	% of Total	\$ Loss	% of Total
Alberta	176	2.68	10 484 328	7.56
British Columbia	270	4.05	10 178 547	6.62
Manitoba	100	1.77	10 013 283	15.46
New Brunswick	71	2.82	560 774	1.41
Newfoundland	N/A	N/A	N/A	N/A
Nova Scotia	39	2.44	485 563	3.18
Ontario	696	3.82	15 627 580	5.42
Prince Edward Island	N/A	N/A	N/A	N/A
Quebec	348	3.40	17 220 057	4.51
Saskatchewan	55	1.34	3 826 268	9.21
Northwest Territories	11	8.33	8 347 100	57.41
Yukon	4	1.68	65 000	5.87
National Defence	19	6.23	102 388	6.52
Indian Reserves	N/A	N/A	N/A	N/A
Federal Properties	4	3.39	555 020	52.92
Total	1 793	3.11	77 465 908	6.59

Percentages used in this table relate to jurisdictional totals.

3(d) Assembly - Detail

Occupancy	Number of Fires	\$ Loss	Injuries	Deaths
Theatre, studio, auditorium	31	159 807	1	0
Amusement, recreation place	141	5 086 405	6	0
School, college, university	521	18 800 716	25	0
Church, funeral parlour	78	9 265 506	4	0
Club, social, sport	79	3 788 309	10	0
Museum, art gallery, library	27	172 900	0	0
Food, beverage establishment	437	20 161 211	34	0
Passenger terminal, station	51	397 386	2	0
Miscellaneous	428	18 197 668	4	0
Total	1 793	77 465 908	86	0

3(e) Institutional

Jurisdiction	Number of Fires	% of Total	\$ Loss	% of Total
Alberta	45	0.68	393 225	0.28
British Columbia	27	0.40	428 275	0.28
Manitoba	50	0.88	699 505	1.08
New Brunswick	35	1.39	344 497	0.86
Newfoundland	N/A	N/A	N/A	N/A
Nova Scotia	12	0.75	145 188	0.95
Ontario	154	0.85	1 198 303	0.42
Prince Edward Island	N/A	N/A	N/A	N/A
Quebec	90	0.88	11 874 191	3.11
Saskatchewan	11	0.27	300	0.00
Northwest Territories	0	0.00	0	0.00
Yukon	2	0.84	100	0.01
National Defence	1	0.33	25	0.00
Indian Reserves	N/A	N/A	N/A	N/A
Federal Properties	100	84.75	62 817	5.99
Total	527	0.92	15 146 426	1.29

Percentages used in this table relate to jurisdictional totals.

3(f) Institutional - Detail

Occupancy	Number of Fires	\$ Loss	Injuries	Deaths
Prison, jail, reformatory	157	711 050	13	0
Home for the aged	112	412 839	6	1
Child care	18	461 623	0	0
Hospital, sanatorium, clinic	111	940 159	23	1
Miscellaneous	129	12 620 755	4	2
Total	527	15 146 426	46	4

3(g) Business and Personal Service

Jurisdiction	Number of Fires	% of Total	\$ Loss	% of Total
Alberta	47	0.72	2 549 334	1.84
British Columbia	56	0.84	4 197 948	2.73
Manitoba	35	0.62	1 474 027	2.28
New Brunswick	18	0.72	324 868	0.81
Newfoundland	N/A	N/A	N/A	N/A
Nova Scotia	16	1.00	758 253	4.97
Ontario	244	1.34	8 446 614	2.93
Prince Edward Island	N/A	N/A	N/A	N/A
Quebec	199	1.94	11 882 721	3.11
Saskatchewan	11	0.27	210 148	0.51
Northwest Territories	1	0.76	225 000	1.55
Yukon	1	0.42	0	0.00
National Defence	8	2.62	14 945	0.95
Indian Reserves	N/A	N/A	N/A	N/A
Federal Properties	3	2.54	125 000	11.92
Total	639	1.11	30 208 858	2.57

Percentages used in this table relate to jurisdictional totals.

3(h) Mercantile Properties

Jurisdiction	Number of Fires	% of Total	\$ Loss	% of Total
Alberta	125	1.90	6 653 363	4.80
British Columbia	160	2.40	14 476 692	9.41
Manitoba	67	1.18	2 879 923	4.45
New Brunswick	62	2.46	967 444	2.42
Newfoundland	N/A	N/A	N/A	N/A
Nova Scotia	38	2.37	1 551 003	10.17
Ontario	501	2.75	18 370 091	6.37
Prince Edward Island	N/A	N/A	N/A	N/A
Quebec	444	4.34	37 137 456	9.72
Saskatchewan	25	0.61	2 753 508	6.63
Northwest Territories	3	2.27	1 427 000	9.81
Yukon	1	0.42	0	0.00
National Defence	8	2.62	60 615	3.86
Indian Reserves	N/A	N/A	N/A	N/A
Federal Properties	1	0.85	3 000	0.29
Total	1 435	2.49	86 280 095	7.34

Percentages used in this table relate to jurisdictional totals.

3(i) Industrial Manufacturing Properties

Jurisdiction	Number of Fires	% of Total	\$ Loss	% of Total
Alberta	131	1.99	11 235 130	8.10
British Columbia	146	2.19	14 757 156	9.60
Manitoba	51	0.90	7 973 324	12.31
New Brunswick	66	2.62	22 023 686	55.19
Newfoundland	N/A	N/A	N/A	N/A
Nova Scotia	31	1.94	2 784 566	18.26
Ontario	540	2.96	20 800 766	7.22
Prince Edward Island	N/A	N/A	N/A	N/A
Quebec	444	4.34	64 401 276	16.85
Saskatchewan	37	0.90	2 108 779	5.08
Northwest Territories	0	0.00	0	0.00
Yukon	1	0.42	150 000	13.55
National Defence	0	0.00	0	0.00
Indian Reserves	N/A	N/A	N/A	N/A
Federal Properties	0	0.00	0	0.00
Total	1 447	2.51	146 234 683	12.44

Percentages used in this table relate to jurisdictional totals.

3(j) Storage Properties

Jurisdiction	Number of Fires	% of Total	\$ Loss	% of Total
Alberta	403	6.13	16 520 032	11.91
British Columbia	179	2.68	10 953 602	7.12
Manitoba	212	3.75	3 234 276	4.99
New Brunswick	116	4.61	1 963 060	4.92
Newfoundland	N/A	N/A	N/A	N/A
Nova Scotia	9	0.56	120 150	0.79
Ontario	289	1.59	5 489 866	1.90
Prince Edward Island	N/A	N/A	N/A	N/A
Quebec	83	0.81	6 938 633	1.82
Saskatchewan	142	3.47	3 243 478	7.81
Northwest Territories	1	0.76	5 000	0.03
Yukon	0	0.00	0	0.00
National Defence	15	4.92	61 087	3.89
Indian Reserves	N/A	N/A	N/A	N/A
Federal Properties	1	0.85	2 500	0.24
Total	1 450	2.52	48 531 684	4.13

Percentages used in this table relate to jurisdictional totals.

3(k) Special Properties (Outdoor and Vehicles)

Jurisdiction	Number of Fires	% of Total	\$ Loss	% of Total
Alberta	3 228	49.13	23 672 078	17.06
British Columbia	3 280	49.19	20 002 253	13.01
Manitoba	3 468	61.28	8 431 729	13.02
New Brunswick	575	22.85	926 255	2.32
Newfoundland	N/A	N/A	N/A	N/A
Nova Scotia	271	16.93	974 049	6.39
Ontario	6 495	35.65	33 832 060	11.73
Prince Edward Island	N/A	N/A	N/A	N/A
Quebec	1 196	11.69	23 492 274	6.15
Saskatchewan	2 800	68.33	9 470 945	22.80
Northwest Territories	40	30.30	394 700	2.71
Yukon	143	57.98	117 010	10.57
National Defence	195	63.93	477 635	30.42
Indian Reserves	N/A	N/A	N/A	N/A
Federal Properties	2	1.69	75 400	7.19
Total	21 688	37.65	121 857 388	10.36

Percentages used in this table relate to jurisdictional totals.

3(l) Special Properties - Detail

Occupancy	Number of Fires	\$ Loss	Injuries	Deaths
Outdoor property	6 343	2 902 612	77	7
Special connecting properties	41	260 217	1	0
Construction, demolition, vacant	248	5 415 670	10	0
Watercraft	136	1 863 988	7	0
Rail, transport vehicle and equipment	65	2 259 425	4	0
Ground transport vehicle	13 536	84 072 380	120	31
Aircraft	6	197 999	0	0
Special vehicle	1 309	24 574 047	12	1
Pier, wharf	4	311 050	0	0
Total	21 688	121 857 388	231	39

3(m) Farm Properties

Jurisdiction	Number of Fires	% of Total	\$ Loss	% of Total
Alberta	342	5.21	8 094 601	5.84
British Columbia	59	0.88	4 408 762	2.87
Manitoba	107	1.89	5 062 414	7.82
New Brunswick	15	0.60	506 749	1.27
Newfoundland	N/A	N/A	N/A	N/A
Nova Scotia	28	1.75	438 499	2.88
Ontario	239	1.31	13 239 045	4.59
Prince Edward Island	N/A	N/A	N/A	N/A
Quebec	0	0.00	0	0.00
Saskatchewan	121	2.95	1 858 089	4.47
Northwest Territories	0	0.00	0	0.00
Yukon	0	0.00	0	0.00
National Defence	1	0.33	355 000	22.61
Indian Reserves	N/A	N/A	N/A	N/A
Federal Properties	0	0.00	0	0.00
Total	912	1.58	33 963 159	2.89

Percentages used in this table relate to jurisdictional totals.

3(n) Miscellaneous Properties

Jurisdiction	Number of Fires	% of Total	\$ Loss	% of Total
Alberta	329	5.01	11 422 173	8.23
British Columbia	159	2.38	1 427 343	0.93
Manitoba	197	3.48	2 044 015	3.16
New Brunswick	118	4.69	411 740	1.03
Newfoundland*	*573	100.00	*21 934 917	100.00
Nova Scotia	20	1.25	1 300	0.01
Ontario	1 643	9.02	10 485 655	3.64
Prince Edward Island	N/A	N/A	N/A	N/A
Quebec	249	2.43	29 262 020	7.66
Saskatchewan	160	3.90	2 026 688	4.88
Northwest Territories	13	9.85	301 890	2.08
Yukon	6	2.52	11 575	1.05
National Defence	22	7.21	33 065	2.11
Indian Reserves*	*670	100.00	*10 944 651	100.00
Federal Properties	6	5.08	225 000	21.45
Total	4 165	7.23	90 532 032	7.70

Percentages used in this table relate to jurisdictional totals.

* 1998 total losses for Newfoundland and Indian Reserves has been included in this table.

Section IV

Table 4 - Arson

Jurisdiction	Actual Number	Offences Cleared		Persons Charged		Male Young Offenders	Female Young Offenders
		By Charge	Otherwise	Male Adults	Female Adults		
Alberta	1 023	159	127	76	20	50	13
British Columbia	2 713	127	224	69	6	57	14
Manitoba	669	124	66	43	18	39	9
New Brunswick	301	26	52	108	13	21	13
Newfoundland	135	23	6	7	0	11	1
Nova Scotia	422	62	31	29	6	30	1
Ontario	3 437	356	375	160	37	152	22
Prince Edward Island	30	2	7	1	0	4	1
Quebec	3 806	318	266	185	47	77	7
Saskatchewan	343	43	56	21	4	19	1
Northwest Territories	41	3	14	3	0	1	0
Yukon	32	4	11	4	1	0	0
Total	12 952	1 247	1 235	706	152	461	82

Source: Canadian Centre for Justice Statistics - Statistics Canada. This table contains the numbers of arsons reported to the police department and would not necessarily mean a fire.

Section V

Table 5 - Fire Losses by Source of Ignition

Source of Ignition (Igniting Object)	Number of Fires	\$ Loss	<u>Injuries</u>					<u>Deaths</u>					
			FF	M	W	C	Uncl.	FF	M	W	C	Uncl.	
No igniting object (e.g., lightning)	412	11 480 924	6	2	1	0	0	0	0	0	0	0	0
Cooking equipment	6 230	69 898 730	52	245	176	61	69	0	13	18	0	0	0
Heating equipment	5 293	117 123 860	46	74	17	14	9	2	9	9	1	1	0
Appliances and equipment	2 353	77 258 767	31	42	24	16	4	0	6	0	1	0	0
Electrical distribution equipment	4 832	117 672 439	68	65	17	8	8	0	4	4	3	0	0
Other electrical equipment	2 829	26 295 562	19	31	12	6	9	0	2	0	2	0	0
Smoker's material and "open flame":													
Smoker's material	3 260	41 631 959	87	120	70	16	18	0	39	31	14	1	0
Match, lighter (not used with smoking), lamp, candle, taper	2 593	51 310 766	39	55	53	33	9	0	3	5	2	0	0
Cutting torch, welding equipment, varied torches	835	19 126 592	26	28	2	1	5	0	0	1	0	0	0
Hot ashes, embers (non-smoking material)	552	8 053 353	10	25	4	0	0	0	2	1	0	0	0
Smoker's material or "open flame", unclassified	4 295	100 643 454	31	45	27	19	2	0	25	6	3	0	0
Exposure	2 844	36 714 974	8	22	5	0	5	0	2	0	0	0	0
Miscellaneous	8 929	211 368 983	101	114	31	14	65	0	34	14	3	6	0
Undetermined	12 345	286 972 772	195	144	67	23	46	0	30	20	15	5	0
Total	57 602	1 175 553 135	719	1 012	506	211	249	2	169	109	44	13	0

FF - Firefighters M - Men W - Women C - Children Uncl. – Unclassified

Figure 3 - Source of Ignition

Summary 1998

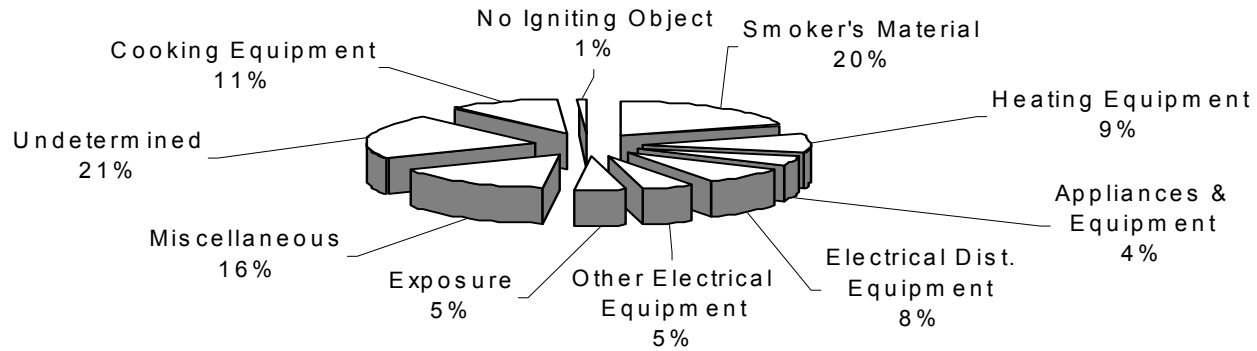

Number of fires

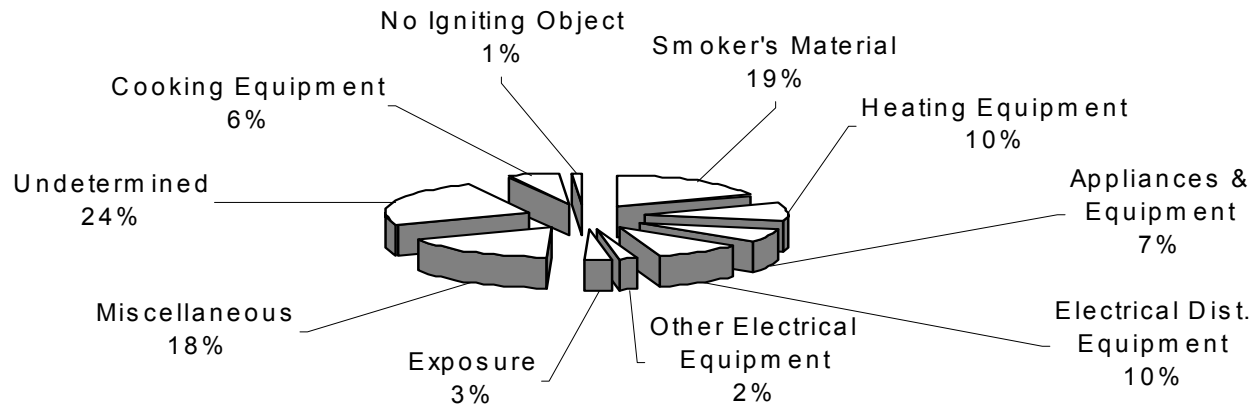

Dollar loss

Section VI

Table 6 - Fire Deaths and Injuries

Table 6(a) - Fire Deaths, 1998 and 10-Year Summary

Jurisdiction	1998					Total	Fire Death Rate *	10-Year Average	
	Firefighters	Men	Women	Children	Unclassified			Average Number of Deaths	Fire Death Rate *
Alberta	0	13	5	2	0	20	0.72	36	1.36
British Columbia	0	14	8	4	4	30	0.75	37	1.07
Manitoba	0	7	7	5	0	19	1.66	23	1.99
New Brunswick	0	1	5	2	0	8	1.60	13	1.86
Newfoundland	0	0	0	0	3	3	0.55	11	2.01
Nova Scotia	0	3	5	3	0	11	1.17	20	2.17
Ontario	0	67	46	19	0	132	1.16	141	1.33
Prince Edward Island	N/A	N/A	N/A	N/A	N/A	N/A	N/A	3	2.57
Quebec	2	56	30	6	0	94	1.32	79	1.13
Saskatchewan	0	8	3	2	0	13	1.26	20	1.96
Northwest Territories	0	0	0	0	0	0	0.00	5	8.09
Yukon	0	1	0	0	0	1	3.13	1	3.29
National Defence	0	0	0	0	0	0	0.00	11	10.05
Indian Reserves	0	0	0	1	5	6	1.84	27	8.70
Federal Properties	0	0	0	0	0	0	0.00	17	5.40
Total	2	170	109	44	12	337	1.11	444	1.53

* Fire death rate - number of fire deaths per 100 000 population per annum

Table 6(b) - Fire Injuries, 1998 and 10-Year Summary

Jurisdiction	1998					Total	Fire Injury Rate *	10-Year Average	
	Firefighters	Men	Women	Children	Unclassified			Average Number of Injuries	Fire Injury Rate *
Alberta	96	197	99	35	0	427	16.21	428	16.21
British Columbia	75	121	47	27	63	333	8.33	402	11.38
Manitoba	75	93	56	23	0	247	21.58	250	22.12
New Brunswick	23	36	9	3	0	71	14.20	233	31.95
Newfoundland	0	0	0	0	1	1	0.18	15	2.64
Nova Scotia	7	7	1	6	0	21	2.23	48	5.24
Ontario	331	347	194	49	124	1 045	9.16	1 571	14.91
Prince Edward Island	0	0	0	0	0	0	0.00	0	0.00
Quebec	94	161	89	60	0	404	5.68	510	7.27
Saskatchewan	8	27	6	6	25	72	7.01	85	8.39
Northwest Territories	6	3	0	2	0	11	16.17	19	32.15
Yukon	0	2	0	0	0	2	6.26	5	15.76
National Defence	4	7	4	0	3	18	20.94	1	0.72
Indian Reserves	0	0	0	7	26	33	10.14	20	6.27
Federal Properties	0	11	1	0	0	12	5.79	10	4.61
Total	719	1 012	506	218	242	2 697	8.87	3 597	12.38

* Fire injury rate - number of fire injuries per 100 000 population per annum

Section VII

Table 7 - Act or Omission Causing Fire

Act or Omission	Number of Fires	\$ Loss	Injuries					Deaths				
			FF	M	W	C	Uncl.	FF	M	W	C	Uncl.
Arson or other set fires:												
Arson/suspected arson	4 226	65 510 128	80	38	21	2	2	0	18	10	4	0
Other set fires	6 398	192 720 211	91	52	40	12	14	2	23	17	6	0
Misuse of source of ignition:												
Smoker's material	1 377	23 185 644	28	33	31	8	13	0	5	5	3	1
Child playing	3 749	55 385 464	80	160	112	44	53	0	25	18	7	0
Welding, cutting, thawing	356	11 255 224	18	7	1	0	2	0	0	0	0	0
Unclassified	1 396	11 240 594	4	17	5	1	3	0	1	1	0	0
Misuse of material ignited	1 956	28 320 457	35	140	71	24	25	0	5	4	0	0
Mechanical, electrical failure, malfunction	12 246	217 807 678	106	110	32	20	17	0	3	6	4	0
Construction, design or installation deficiency	2 699	69 385 890	31	30	8	5	2	0	7	3	0	1
Misuse of equipment	110	2 364 645	0	4	3	0	1	0	0	0	0	0
Human failing:												
Asleep	102	1 440 027	2	15	3	5	2	0	2	0	0	1
Suspected impairment by alcohol, drugs, medication	122	2 307 478	5	20	6	0	4	0	4	3	0	1
Miscellaneous	7 402	125 681 789	51	189	91	54	28	0	29	21	6	0
Vehicle accident	300	4 141 258	1	3	1	0	2	0	3	1	2	0
Miscellaneous	15 163	364 806 648	187	194	81	36	81	0	44	20	12	9
Total	57 602	1 175 553 135	719	1 012	506	211	249	2	169	109	44	13

FF-Firefighters
M-Men
W-Women
C-Children
Unc. – Unclassified

Figure 4 – Act or Omission Causing Fire

Summary 1998

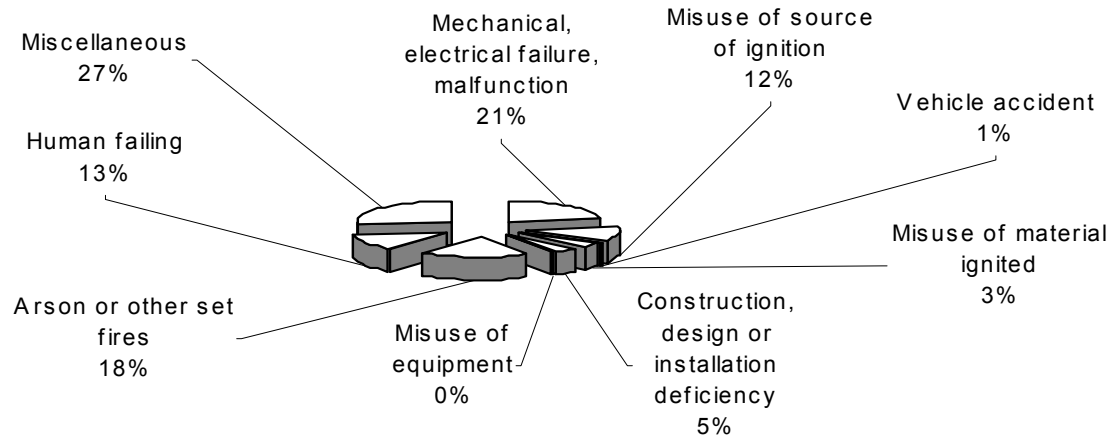

Number of fires

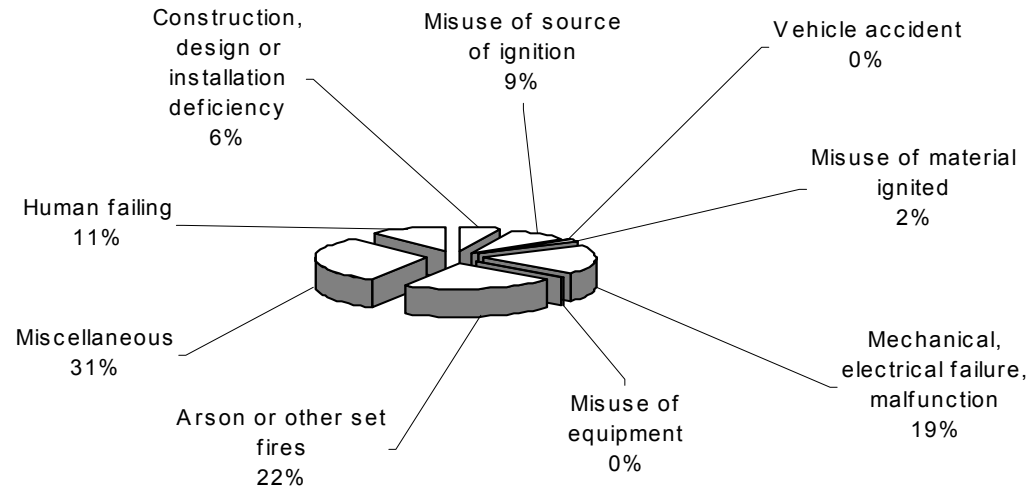

Dollar loss

Section VIII

Table 8 - Losses of \$500 000 and over

Table 8(a) Alberta

Location	Date	Property/Classification	Act or Omission	Dollar Loss	Injuries	Deaths
County # 31	98.01.09	Industrial Mg. Chemicals, Petroleum	Unknown	821,479	0	0
Edmonton	98.01.11	Unclassified	Unknown	1,626,484	0	0
Calgary	98.01.12	Dwelling, year-round	Ignorance of hazard	1,033,107	5	2
Devon	98.01.13	Petroleum refinery	Unknown	700,000	0	0
County # 19	98.01.20	General maintenance shop	Part failure, leak, break	581,000	3	0
Calgary	98.01.24	Business	Smoker's material	2,142,932	4	0
Calgary	98.01.25	Cement Mfg.	Suspected arson	500,000	0	0
M.D. # 44	98.01.28	Unclassified	Unknown	1,085,597	0	0
Airdrie	98.01.30	Petroleum refinery	Part failure, leak, break	1,500,000	0	0
Stony Plain	98.02.08	Grain mill products mfg.	Electrical short circuit – arson	500,000	0	0
Edmonton	98.02.08	Restaurant	Undetermined	800,000	0	0
M.D. # 8	98.02.08	Auditorium, concert hall	Suspected arson	500,000	0	0
Calgary	98.03.28	Church, chapel	Electrical short circuit	1,800,000	2	0
County # 23	98.04.13	Petroleum refinery	Unknown	750,000	0	0
Municipality of Wood Buffalo	98.05.05	Pipeline	Part failure, leak, break	2,000,000	0	0
Provost	98.05.07	Hotel, inn, lodge – year round use	Unknown	602,000	0	0
Calgary	98.05.18	Church, chapel	Arson for vengeful purposes	863,845	0	0
County # 14	98.05.20	Apartment	Welding or cutting too close	950,000	0	0
Spruce Grove	98.06.14	Business	Smoker's material	1,022,836	1	0
Peace River	98.07.04	Warehouse	Smoker's material	927,622	0	0
Edmonton	98.07.30	Nightclub	Motive undetermined	950,000	0	0
Municipality of Wood Buffalo	98.07.30	Petroleum, natural gas well	Part worn out	6,000,000	0	0
Calmar	98.07.31	Supermarket	Arson obscuring other crimes	750,000	0	0
Lloydminster	98.08.20	Basic metal products mfg.	Electrical short circuit	555,000	0	0
Whitecourt	98.09.01	Restaurant	Unknown	1,327,254	0	0
M.D. # 44	98.09.14	Ballroom, gymnasium	Combustible placed too close to heat	1,000,000	0	0
Strathcona County	98.10.06	Petroleum refinery	Part failure, leak, break	700,000	1	0
High Prairie	98.11.03	Elevators, grain	Mechanical, electrical failure	2,250,000	0	0
Hinton	98.11.24	Federal/provincial government office	Undetermined	1,000,000	0	0
County # 26	98.11.29	Agricultural products boxed, crated	Unknown	1,162,554	0	0
M.D. #136	98.12.13	Warehouse	Undetermined	667,465	0	0
County #1	98.12.19	Heavy machinery and equipment storage	Unknown	2,303,258	0	0

Table 8(b) British Columbia

Location	Date	Property/Classification	Act or Omission	Dollar Loss	Injuries	Deaths
Nelson	98.01.01	Country Club	Cannot be determined	878,000	1	0
Sorrento	98.01.03	Ballroom, Gymnasium	Cannot be determined	500,000	0	0
Vancouver	98.01.08	Hotel, inn, lodge: year-round use	Torch too close	850,000	0	0
Vancouver	98.01.15	Food or beverage establishment	Cannot be determined	850,000	0	0
Lillooet	98.01.23	Social, sport club	Suspected set fire – motive unknown	1,002,000	0	0
Richmond	98.01.25	Social, sport club	Arson or set fire	750,000	0	0
Prince Rumbert	98.02.02	Basic metal products manufacturing	Welding or cutting too close	1,000,000	1	0
Kelowna	98.02.09	Restaurant	Cannot be determined	700,000	1	0
Harrison Lake	98.02.10	Maintenance shop, general	Cannot be determined	1,250,000	0	0
Surrey	98.02.14	Variety store	Cannot be determined	1,177,000	0	0
Victoria	98.02.14	General business office	Cannot be determined	880,000	0	0
Richmond	98.02.16	Furniture repair or upholstery	Cannot be determined	527,500	0	0
North Vancouver City	98.02.24	Sporting goods sales, bicycle sales and repairs	Human falling – unclassified	632,000	0	0
North Pender Island	98.02.28	Variety Store	Cannot be determined	500,000	0	0
Vancouver	98.03.01	Miscellaneous business and personal service	Arson or set fire	670,000	2	0
Coquitlam City	98.03.23	Felled timber, log storage	Cannot be determined	620,000	0	0
Surrey	98.04.01	Animal barn, cattles, pigs, horses	Cannot be determined	1,042,000	0	0
Vancouver	98.04.03	Dwelling year-round use	Accident	600,000	0	0
Richmond	98.04.10	Packaged foodstuffs storage	Cannot be determined	795,000	0	0
Vancouver	98.04.14	General business office	Arson or set fire	890,000	0	0
Whistler	98.04.19	Hotel, inn, lodge	Cannot be determined	567,000	0	0
Burnaby	98.04.23	Plastic manufacture	Ignorance of hazard	1,200,000	0	0
Penticton	98.-04.23	Furniture, bedding manufacture	Welding or cutting too close	675,000	1	0
Chilliwack	98.04.29	Agricultural, supply storage	Arson or set fire	1,329,000	0	0
Surrey	98.05.06	Food, beverage sale	Arson or set fire	800,000	0	0
Burnaby	98.05.11	Scrap and junkyards	Suspected set fire – motive unknown	1,600,000	0	0
Burnaby	98.05.13	Appliance store	Part failure, leak, break	2,000,000	0	0
Fort St. John	98.05.13	Books, newspapers, drugs	Cannot be determined	1,030,500	0	0
McBride	98.05.27	Sawmill, planing mill	Miscellaneous act or omission	600,000	0	0
Prince George	98.06.02	Sawmill, planing mill	Welding or cutting too close	550,000	0	0
Kelowna	98.06.10	Motor vehicle repairs	Arson or set fire	500,000	0	0
Vancouver	98.06.14	Apartment, townhouse: over 20 units	Suspected set fire	600,000	1	0
Bulkely-Nechako R.D.	98.06.15	Sawmill, planing mill	Cannot be determined	1,000,000	0	0
Parksville	98.06.22	Apartment, Townhouse: 3-20 units	Suspected faulty connections	1,635,000	1	0
Langley Township	98.06.30	Boxed, crated or packaged storage	Cannot be determined	500,000	0	0
Surrey	98.07.21	Apartment	Cannot be determined	2,990,000	0	0
Abbotsford	98.08.02	Seeds, beans in bulk	Miscellaneous act or omission	1,250,000	0	0

Table 8(b) British Columbia (cont'd)

Location	Date	Property/Classification	Act or Omission	Dollar Loss	Injuries	Deaths
Abbotsford	98.08.08	Plastic products manufacture	Electrical short circuit	650,000	0	0
Nakusp Rural	98.08.21	Sawmill, planing mill	Cannot be determined	1,000,000	0	0
Merritt	98.08.29	Variety store	Cannot be determined	552,500	1	0
Langley Township	98.10.09	Storage barn	Cannot be determined	540,000	0	0
Princeton	98.10.15	Wood, furniture, paper manufacturing	Distracted, preoccupied	700,000	0	0
Kelowna	98.10.24	Slaughtering, preparing, preserving of meat	Misuse of source of ignition	1,300,000	0	0
Port Coquitlam	98.10.28	Apartment, townhouse	Torch too close	500,000	0	0
Vancouver	98.10.28	Restaurant	Torch too close	725,000	1	0
Delta	98.11.15	Apartment, townhouse: over 20 units	Accident	604,500	4	0
Vancouver	98.12.13	Supermarket	Arson or set fire	500,000	1	0
Mission	98.12.18	Sawmill, planing mill	Accident	1,220,000	0	0

Table 8(c) Manitoba

Location	Date	Property/Classification	Act or Omission	Dollar Loss	Injuries	Deaths
RM of St. Clements	98.03.25	Steam generating plant	Accidental	500,000	0	0
Winnipeg	98.04.07	Church	Incendiary	2,500,000	0	1
Winnipeg	98.04.16	Warehouse	Incendiary	500,000	0	0
Winnipeg	98.04.19	Vehicle Manufacturing	Undetermined	600,000	0	0
Teulon	98.05.29	Restaurant	Accidental	530,000	0	0
Plumas	98.08.09	Grocery store	Accidental	615,173	0	0
Gimli	98.09.28	Restaurant	Undetermined	1,500,000	0	0
Blumenort	98.10.07	Manufacturing	Incendiary	6,000,000	0	1
Moose Lake	98.11.06	Unoccupied property	Incendiary	1,010,000	0	0
RM of Westbourne	98.11.10	Hog barn	Undetermined	2,500,000	0	0
Oakbank	98.12.21	School	Incendiary	3,302,500	0	0

Table 8(d) New Brunswick

Location	Date	Property/Classification	Act or Omission	Dollar Loss	Injuries	Deaths
Eel River Crossing	98.02.09	Miscellaneous	Cannot be determined	904,627	0	1
Saint John	98.06.09	Miscellaneous	Construction deficiency	20,000,000	0	0
Fredericton	98.07.09	Miscellaneous storage	Suspicious	510,261	0	0
Grand Falls	98.10.03	Dwelling – 1 family	Child playing with matches	676,724	0	0
Stanley	98.10.25	Printing	Cannot be determined	582,829	0	0

Table 8(e) Newfoundland

Location	Date	Property/Classification	Act or Omission	Dollar Loss	Injuries	Deaths
Not available						

Table 8(f) Nova Scotia

Location	Date	Property/Classification	Act or Omission	Dollar Loss	Injuries	Deaths
Clark's Harbour	98.08.14	Industrial manufacturing	Installation deficiency	1,500,000	0	0
Antigonish	98.10.10	Business	Vandalism	514,243	0	0

Table 8(g) Ontario

Location	Date	Property/Classification	Act or Omission	Dollar Loss	Injuries	Deaths
Toronto	98.01.22	Service station	Undetermined	550,000	0	0
New Liskeard	98.02.06	Motor vehicle repair	Misuse of material ignited	1,000,000	0	0
Windsor	98.02.09	Detached dwelling	Electrical failure	500,000	0	0
Mississauga	98.02.14	Secondary metal processing	Electrical failure	2,500,000	0	0
Elizabethtown	98.02.24	Barn, animal shelter	Undetermined	500,000	0	0
Toronto	98.03.02	Recycling facility	Undetermined	750,000	0	0
Georgina	98.03.08	Marina, marine service	Undetermined	1,200,000	0	0
London	98.03.30	Book, art supply	Undetermined	500,000	0	0
North Stormont	98.04.08	Barn, animal shelter	Undetermined	850,000	0	0
Aurora	98.04.09	Detached dwelling	Maintenance deficiency	756,500	0	0
Hamilton	98.04.13	Miscellaneous	Youth vandalism	500,000	2	0
Toronto	98.04.14	Motor vehicle repair garage	Undetermined	600,000	1	0
Windsor	98.04.23	Multi-unit dwelling	Undetermined	500,000	0	0
Mississauga	98.04.26	Church	Undetermined	2,500,000	0	0
Hawkebury	98.05.01	Tannery	Misused ignition source	500,000	0	0
Belleville	98.05.05	Restaurants	Undetermined	650,000	3	0
Muskoka	98.05.07	Detached dwelling	Design deficiency	580,000	0	0
Muskoka	98.05.07	Detached dwelling	Undetermined	500,000	0	0
Muskoka	98.05.08	Detached dwelling	Design deficiency	580,000	0	0
Toronto	98.05.10	Motor vehicle repair garage	Undetermined	700,000	0	0
Toronto	98.05.16	Hydro distribution facility	Electrical failure	900,000	3	0
Nepean	98.05.22	Secondary processing	Undetermined	500,000	1	0
Grimsby	98.05.23	Restaurant	Misused ignition source	500,000	1	0
North Bay	98.06.12	Apartment	Undetermined	2,100,000	0	0
Innisfil Township	98.06.30	Bar, tavern, night club	Undetermined	900,000	0	0
North Stormont	98.07.13	Barn, animal shelter	Undetermined	512,000	0	0
Markham	98.07.19	School – elementary	Undetermined	2,100,000	0	0
St. Thomas	98.07.20	Motor vehicle repair garage	Vehicle accident	500,000	1	0
Aurora	98.07.22	Detached dwelling	Undetermined	550,000	0	0
Toronto	98.07.24	Semi-detached dwelling	Electrical failure	500,000	2	0
Alvinston	98.08.09	Barn, animal shelter	Undetermined	500,000	0	0
Fort Erie	98.08.11	Other business	Undetermined	3,800,000	0	0
Perry	98.09.30	Other chemical	Undetermined	500,000	0	0
Burlington	98.08.30	Dental/medical office	Other	500,000	0	0
Newmarket	98.09.13	Detached dwelling	Undetermined	500,000	0	0
Toronto	98.09.16	Room, boarding, lodging	Arson	555,000	5	2
Mapleton	98.09.18	Barn, animal shelter	Misused ignition source	600,000	1	1
Chatham-Kent	98.09.27	Clothing store	Undetermined	550,000	1	0
Matachewan	98.09.28	Detached dwelling	Mechanical failure	500,000	0	0
Parry Sound Town	98.10.04	Apartment, flat	Misuse of material ignited	625,000	0	0
Toronto	98.10.19	Detached dwelling	Undetermined	635,000	0	0
Hagarty & richards	98.10.19	Primary processing	Undetermined	1,000,000	0	0
Chatham-Kent	98.10.22	Bar, tavern, night club	Arson	750,000	0	0
Osgood Township	98.10.27	Industrial	Undetermined	500,000	0	0
Springer	98.10.31	Detached garage	Misuse of material ignited	500,000	0	0
Hamilton	98.11.01	Other miscellaneous	Children playing with matches	500,000	0	0

Table 8(g) Ontario (cont'd)

Location	Date	Property/Classification	Act or Omission	Dollar Loss	Injuries	Deaths
Hamilton	98.11.06	School	Electrical failure	875,000	1	0
Kitchener	98.11.15	Grain products	Undetermined	650,000	0	0
Mississauga	98.11.21	Gas processing plant	Undetermined	650,000	0	0
Peterborough	98.11.28	Multi-unit dwelling	Riot/civil commotion	1,050,000	0	0
Georgina	98.12.03	Detached dwelling	Arson	550,000	0	1
Vaughan	98.12.29	Large truck	Undetermined	500,000	0	0

Table 8(h) Prince Edward Island

Location	Date	Property/Classification	Act or Omission	Dollar Loss	Injuries	Deaths
Not available						

Table 8(i) Quebec

Location	Date	Property/Classification	Act or Omission	Dollar Loss	Injuries	Deaths
Hampstead	98.01.01	Dwelling	Mechanical/electrical failure	500,000	0	0
Mansfield-Pontefract	98.01.03	Sawmill, planing mill	Undetermined	2,098,280	1	0
Saint-Mathias-sur-Richelieu	98.01.04	Food industry	Mechanical/electrical failure	1,841,067	0	0
La Tuque	98.01.04	New/used car dealer	Undetermined	869,694	0	0
Rigaud	98.01.06	Offices, government	Mechanical/electrical failure	800,000	0	0
Saint-Lambert	98.01.07	Dwelling	Undetermined	561,414	0	0
Chicoutimi	98.01.08	Industrial equipment	Negligence	600,000	0	0
Montreal	98.01.10	Dwelling	Negligence	1,000,000	0	0
Sainte-Therese	98.01.11	Dwelling	Construction deficiency	514,811	0	0
Iberville	98.01.15	Variety store	Unknown	910,628	1	0
Sainte-Catherine	98.01.15	Dwelling	Negligence	800,303	0	0
Saint-Jean-sur-Richelieu	98.01.16	Restaurant	Unknown	1,186,456	0	0
Montreal	98.01.19	Department store	Unknown	971,964	0	0
Chambly	98.01.20	Bar, tavern, night club	Unknown	554,000	0	0
Granby	98.01.26	Dwelling	Mechanical/electrical failure	1,234,000	0	0
Montreal	98.01.28	Dwelling	Negligence	516,737	0	0
Quebec	98.02.09	Dwelling	Unknown	600,000	0	0

Table 8(i) Quebec (cont'd)

Location	Date	Property/Classification	Act or Omission	Dollar Loss	Injuries	Deaths
Saint-Thomas-D'Aquin	98.02.11	Wood, furniture manufacturing	Mechanical/electrical failure	1,015,350	0	0
Sainte-Julienne	98.02.13	Slaughtering, preparing, preserving of meat	Unknown	670,000	0	0
Sainte-Anne-des-Plaines	98.03.01	Supermarket	Unknown	2,070,000	5	0
Coaticook	98.03.04	Office	Undetermined	795,445	0	0
Shawinigan	98.03.07	Bowling alley	Unknown	4,312,242	2	0
Saint-Urbain-Premier	98.03.20	Pigs farm	Mechanical/electrical failure	539,493	0	0
Saint-Elie-D'Orford	98.03.21	Rubber plant	Mechanical/electrical failure	1,000,000	0	0
Yamachiche	98.03.21	Metal industry	Negligence	2,143,700	0	0
Sainte-Marguerine	98.03.23	Gas station	Undetermined	790,000	0	0
Saint-Bruno	98.03.23	Agriculture	Undetermined	4,700,000	0	0
Rouyn-Noranda	98.03.25	Commercial building	Unknown	634,204	0	0
Quebec	98.04.06	Chemical manufacturing	Negligence	1,000,000	0	0
Montreal	98.04.07	Clothing store	Negligence	569,709	0	0
Roberval	98.04.11	Sawmill, planing mill	Unknown	2,400,000	0	0
Val-d'Or	98.04.15	Other business	Negligence	600,000	0	0
Chicoutimi	98.04.28	New/used car dealer	Undetermined	3,000,000	0	0
Kirkland	98.04.29	Pharmaceutical medical industry	Negligence	700,000	0	0
Montreal	98.05.11	Hotel, inn, lodge	Unknown	614,944	1	0
Napierville	98.05.13	Farm	Unknown	800,000	0	0
Brossard	98.05.16	Shopping mall	Unknown	969,834	0	0
Anjou	98.05.20	Pharmaceutical/medical industry	Unknown	1,573,056	9	0
Aylmer	98.05.30	Dwelling	Negligence	936,135	0	0
Dollar-des-Ormeaux	98.06.07	Dwelling	Undetermined	1,231,121	3	0
Trois-Rivieres	98.06.08	Warehouse	Unknown	1,446,000	0	0
Port-Joli	98.06.09	Sawmill	Mechanical/electrical failure	1,000,000	0	0
Montreal	98.06.09	Office	Unknown	2,900,000	15	3
Dolbeau-Mistassini	98.06.22	Commercial building	Undetermined	1,298,700	0	0
Cowansville	98.06.24	Hardware store	Unknown	2,150,000	2	0
Montreal	98.06.28	Inn, hotel	Unknown	525,091	0	0
Acton Vale	98.06.29	Flooring	Unknown	22,500,000	8	2
Rouyn-Noranda	98.06.30	Cleaning	Undetermined	850,000	1	0
Saint-Laurent	98.07.02	Wood manufacturing	Undetermined	1,181,000	0	0
Montreal	98.07.03	School	Negligence	500,000	1	0
Saint-Laurent	98.07.06	Department store	Negligence	2,015,000	0	0
Trois-Rivieres	98.07.11	Hotel, inn, lodge	Unknown	621,654	0	0
Saint-Bernard	98.07.17	Agriculture	Natural cause	1,000,000	0	0
Saint-Denis-de-Brompton	98.07.20	Construction material	Mechanical/electrical failure	3,400,000	0	0
Racine	98.07.29	Farm	Natural cause	850,727	0	0
Saint-Jules	98.07.30	Chemical industry	Negligence	1,626,469	0	0
Trois-rivieres	98.07.31	Industry	Mechanical/electrical failure	700,000	0	0
Sherbrooke	98.07.31	Metal scrap	Unknown	550,000	0	0
Terrebonne	98.08.01	Dwelling	Negligence	700,000	0	0
Montreal	98.08.03	Dwelling	Negligence	604,100	0	0
Rouyn-Noranda	98.08.12	Motor vehicle accessories	Mechanical/electrical failure	1,057,100	0	0
Compton	98.08.21	Pigs farm	Undetermined	578,500	0	0

Table 8(i) Quebec (cont'd)

Location	Date	Property/Classification	Act or Omission	Dollar Loss	Injuries	Deaths
Delson	98.08.22	Felled timber	Mechanical/electrical failure	5,934,051	0	0
Iberville	98.08.23	Electrical products manufacturing	Mechanical/electrical failure	1,008,336	0	0
Saint-Isidore	98.09.03	Shopping mall (14 stores)	Unknown	563,243	0	0
Cap-Chat	98.09.11	Furniture manufacturing	Mechanical/electrical failure	1,450,000	0	0
Montreal	98.09.12	Dwelling	Undetermined	606,322	0	0
Jonquiere	98.09.15	Public utilities	Mechanical/electrical failure	1,000,000	0	0
Baie-Comeau	98.09.23	Paper products industry	Mechanical/electrical failure	717,000	2	0
Senneterre	98.09.24	School elementary	Mechanical/electrical failure	580,000	0	0
Saint-Mathieu	98.09.28	Bar, tavern, night club	Unknown	750,000	0	0
Sherbrooke	98.09.30	Warehouse	Unknown	550,000	0	0
Baie-Comeau	98.10.19	Bar, tavern, night club	Unknown	600,000	0	0
Montreal	98.10.23	Department store	Negligence	510,000	0	0
Beaconsfield	98.11.04	Outside utilities	Unknown	500,000	0	0
Saint-Gervais	98.11.07	Metal products manufacturing	Unknown	850,000	0	0
Saint-Mathias-sur-Richelieu	98.11.19	Department store	Negligence	800,000	0	0
Beaconsfield	98.11.27	Outside utilities	Unknown	500,000	0	0
Montreal	98.11.29	Office building	Mechanical/electrical failure	593,463	0	0
Roberval	98.12.01	Hospital	Unknown	11,000,000	0	0
Montreal	98.12.07	Outside utilities	Undetermined	1,497,000	0	0
Saint-Felix-de-Valois	98.12.12	Farm	Undetermined	898,452	0	0
La Sarre	98.12.14	Leasing equipment	Unknown	620,840	0	0
Sainte-Praxede	98.12.17	Farm	Unknown	983,586	0	0
Saint-Leonard	98.12.18	General manufacturing	Mechanical/electrical failure	800,000	0	0
Hebertville	98.12.20	Hotel, inn, lodge	Unknown	900,000	0	0
Albanel	98.12.23	Hotel, inn, lodge	Construction deficiency	504,124	0	0
Trois-Rivieres	98.12.25	Dwelling	Unknown	645,000	0	0
Gatineau	98.12.26	Bar, tavern, night club	Unknown	1,650,000	0	0
Saint-Ambroise	98.12.28	Motor vehicle garage	Undetermined	508,000	0	0

Table 8(j) Saskatchewan

Location	Date	Property/Classification	Act or Omission	Dollar Loss	Injuries	Deaths
Meadow Lake	98.04.11	Sawmill, planing mills	Mechanical/electrical failure	500,000	0	0
Orkney Rm	98.05.31	Dwelling, year-round use	Incendiary	560,000	0	0
Swift Current	98.06.09	Hardware store	Undetermined	1,600,000	0	0
Moose Jaw	98.06.14	Motor vehicles and trailer sales	Human failing	500,000	0	0
Meadow Lake	98.08.21	Lumberyard, building material	Inadequate control of open fire	2,000,000	0	0
Regina	98.08.30	Apartment, flat	Incendiary	2,066,947	0	0
Weyburn	98.10.06	Restaurant	Mechanical/electrical failure	800,000	0	0
Lumsden	98.11.21	Hotel, inn, lodge – year-round use	Undetermined	600,000	0	0

Table 8(k) Northwest Territories

Location	Date	Property/Classification	Act or Omission	Dollar Loss	Injuries	Deaths
Ft. McPherson	98.04.04	Hotel	Arson	1,200,000	0	0
Deline	98.05.01	Store	Arson	1,400,000	0	0
Cambridge Bay	98.08.03	School	Accident	7,800,000	0	0
Iqaluit	98.12.06	Residential	Child playing with matches	1,000,000	0	0

Table 8(l) Yukon

Location	Date	Property/Classification	Act or Omission	Dollar Loss	Injuries	Deaths
Upper Liard	98.05.02	Special connecting properties	Undetermined	650,000	0	0
Whitehorse	98.08.15	School, college, university	Welding, cutting	1,500,000	0	0

Table 8(m) National Defence

Location	Date	Property/Classification	Act or Omission	Dollar Loss	Injuries	Deaths
None						

Table 8(n) Indian Reserves

Location	Date	Property/Classification	Act or Omission	Dollar Loss	Injuries	Deaths
Not available						

Table 8(o) Federal Jurisdiction

Location	Date	Property/Classification	Act or Omission	Dollar Loss	Injuries	Deaths
Rigaud	98.01.06	Revenu Canada college	Over fusing	500,000	0	0

ORDER FORM

1998 Annual Report of Fire Losses in Canada

Please print:

Name: _____

Organization: _____

Street: _____

City: _____ Province: _____ Postal Code: _____

Telephone: _____ Fax: _____

Number of copies required (\$10.00 CAN each, taxes included) : _____ X \$10.00 = \$ _____. Cheque in the amount of \$ _____ made payable to the Council of Canadian Fire Marshals and Fire Commissioners.

Do you wish to: remain 9 be added 9; or be deleted 9 from our mailing list

PLEASE RETURN COPY OF THIS ORDER FORM TO:

Mr. Tom Makey
c/o Council of Canadian Fire Marshals and Fire Commissioners
Fax: (780) 416-4995
e-mail: tmakey@shaw.ca

Provincial and Territorial Fire Marshals and Fire Commissioners

Mr. R. McCullough
Fire Commissioner
Saskatchewan Municipal Affairs
Office of the Fire Commissioner
1855 Victoria Avenue, Suite 310
Regina, Saskatchewan
S4P 3V7

Mr. R. Dumala
Fire Commissioner
Ministry Of Municipal Affairs
P.O. Box 9490, Stn. Prov. Govt.
Victoria, British Columbia
V8W 9N7

Mr. Robert Cormier
Fire Marshal
Department of Labour
P.O. Box 697
5151 Terminal Rd.
Halifax, Nova Scotia
B3J 2T8

Mr. Fred Hollett
Fire Commissioner
Department Of Municipal and Provincial Affairs
Deer Lake Headquarters
2 Wellon Drive
Deer Lake, Newfoundland
A8A 2G5

Ms. Philippa Gourley
Fire Marshal
Department of Public Safety
65 Brunswick Street, 3rd floor
Fredericton, New Brunswick
E3B 1G5

Mr. D. Gillis
Fire Marshal
Emergency Services Division
Municipality and Community Affairs
Government Of N.W.T.
Northwest Tower 600, 5201-50th Avenue
Yellowknife, Northwest Territories
X1A 3S9

Mr. David Blacquiere
Fire Marshal
Community Affairs and Attorney General
31 Gordon Drive, P.O. Box 2000
Charlottetown, Prince Edward Island
C1A 7N8

Mr. Doug Popowich
Fire Commissioner
Manitoba Labour
1601 Van Horne Ave. E.
Brandon, Manitoba
R7A 7K2

Lt. Col. Tony Lovett
Canadian Forces Fire Marshal
Major General George Pearkes Building
Ottawa, Ontario
K1A 0K2

Mr. W.P. Worona
Director
Occupational, Safety and Health
and Fire Prevention Division
Human Resources Development Canada
Ottawa, Ontario
K1A 0J2

Mr. Denis Racicot
Associate Deputy Minister
Civil Security and Fire Safety
2525 Laurier Blvd, 5th floor
Tour des Laurentides
Sainte Foy, Québec
G1V 2L2

Mr. Pat Graham
Fire Commissioner
Alberta Municipal Affairs
Room 601, I.B.M. Building
10808 - 99th Ave.
Edmonton, Alberta
T5K 0G5

Mr. B.A. Moyle
Fire Marshal
Ministry of The Solicitor General
and Correctional Services
Place Nouveau Bldg.
5775 Yonge St. 7th floor
North York, Ontario
M2M 4J1

Mr. J. Holesworth
Fire Marshal
Department of Community Services
2nd And Hansen Streets
P.O. Box 2703
Whitehorse, Yukon
Y1A 2C6

Mr. Tom Makey
Secretary-Treasurer
Council of Canadian Fire Marshals and
Fire Commissioner